

Note: All bullnose edges are 1" radius unless otherwise noted. Coring may vary.

Stretchers

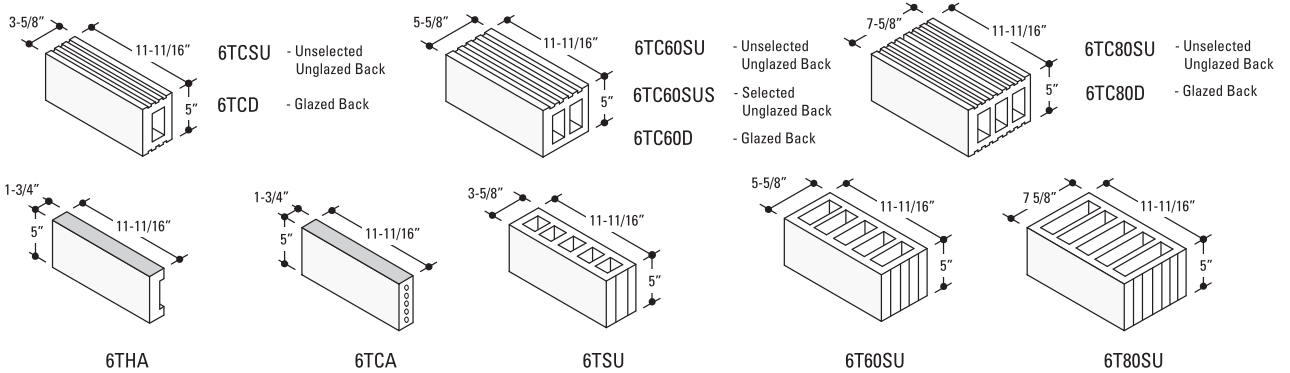

Shapes

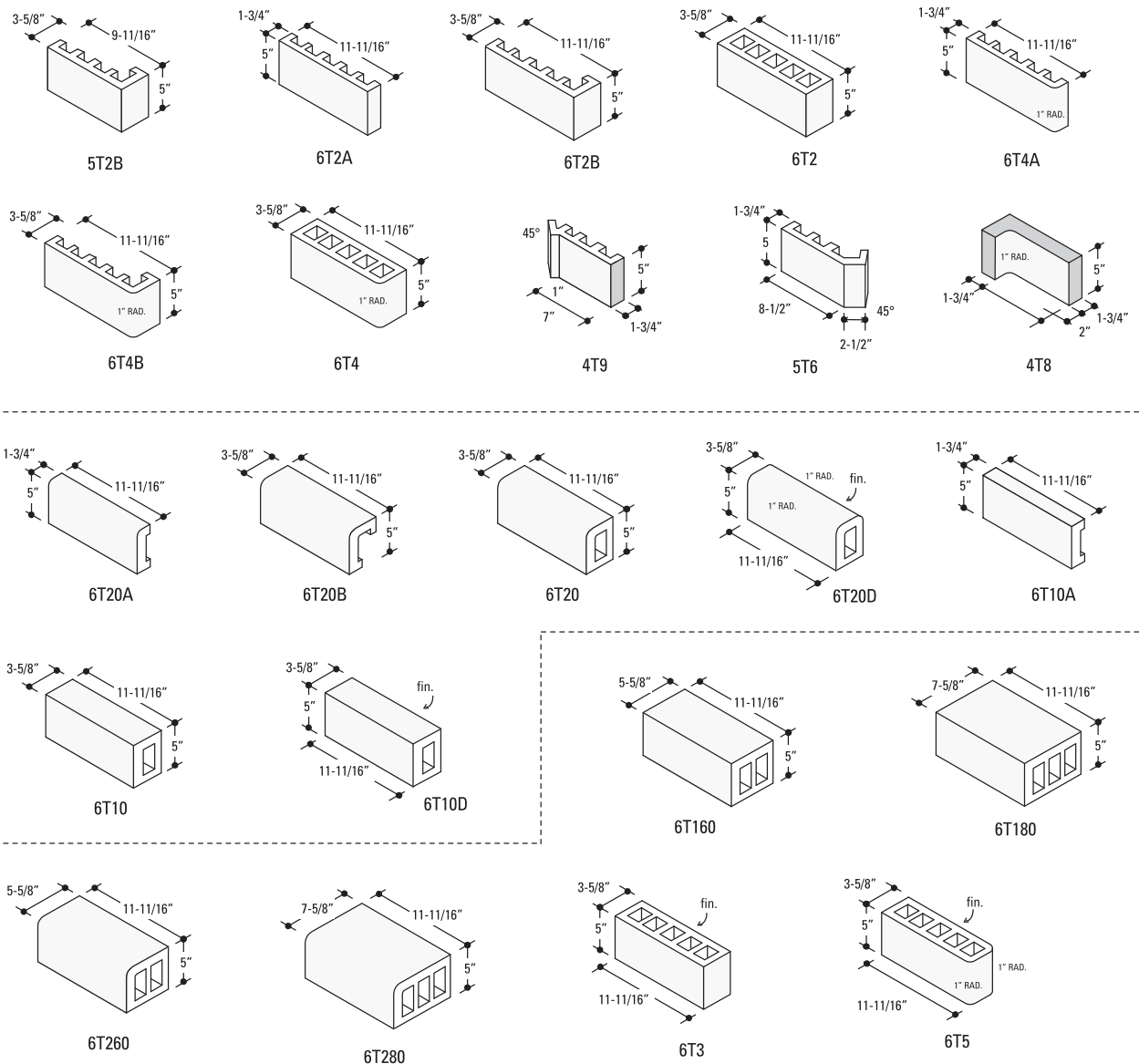

Note: All bullnose edges are 1" radius unless otherwise noted. Coring may vary. L= Left. R= Right. Available in both left and right.

Shapes (cont'd)

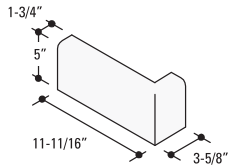

6T22L

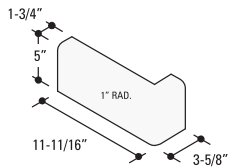

6T24L

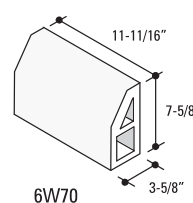

6W70

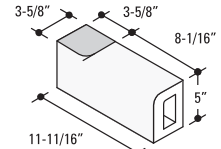

6T31L

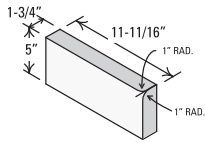

6T30AL

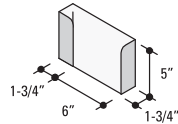

3T27R

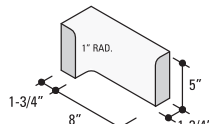

4T28R

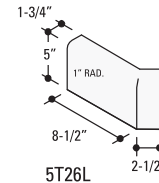

5T26L

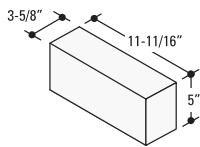

6T12CL

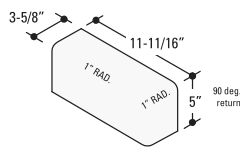

6T24CL

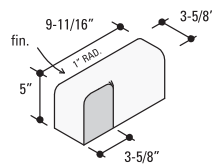

5T24X27R

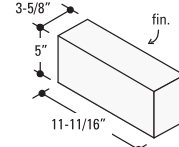

6T13

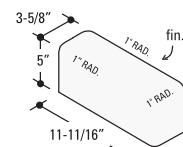

6T25

Recessed Cove Base Profile

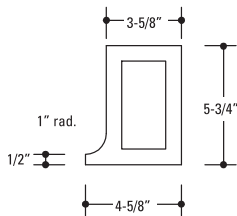

Base Stretchers – Recessed shown with 1/2" lip to accommodate flooring. Also available as Non-Recessed.

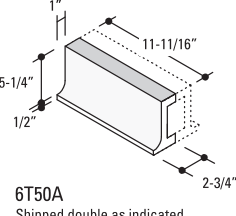

6T50A
Shipped double as indicated

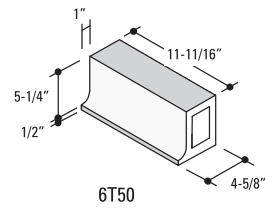

6T50

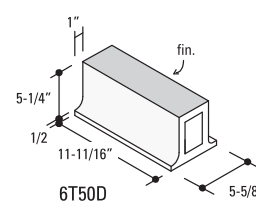

6T50D

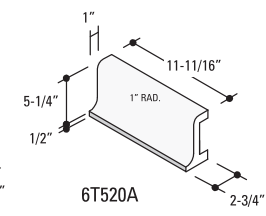

6T520A

Non-Recessed Cove Base Profile

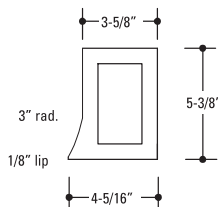

Base Shapes

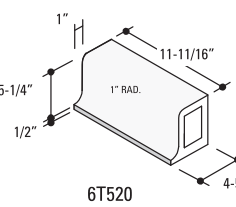

6T520

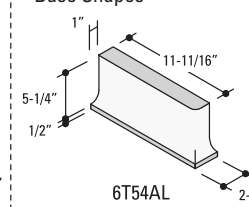

6T54AL

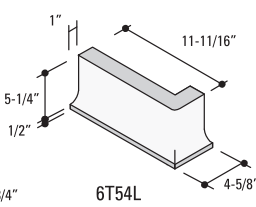

6T54L

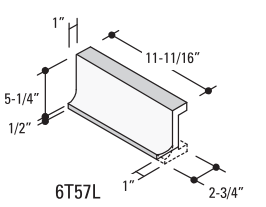

6T57L

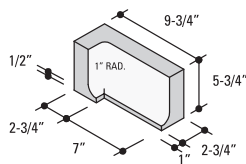

4T58R

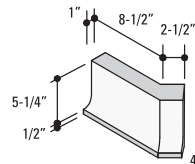

5T56AL

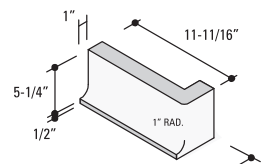

6T504L*

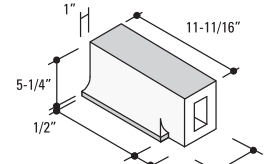

6T502XL*

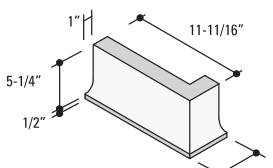

6T52L

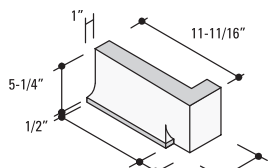

6T502L

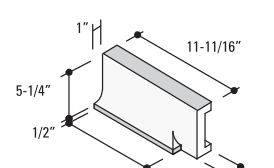

6T502XAL

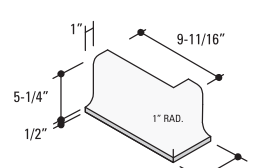

5T524L